

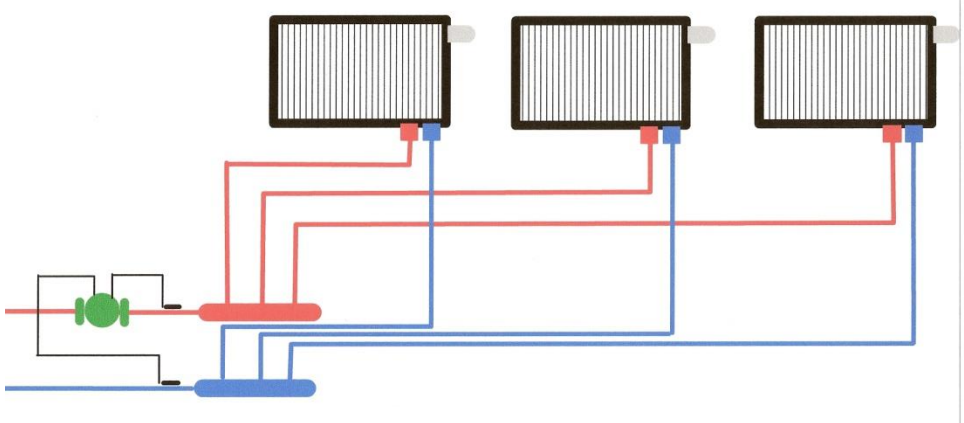

PANEL RADIATOR INSTALLATION MANUAL



Smith's Environmental Products

300 Pond St. Randolph, MA 02368 | Phone: (781) 986 - 2525 | www.smithsenvironmental.com

CONTENTS

- 3. Specifications**
- 5. Tapping Identification**
- 6. Installation Requirements**
- 8. Sizing / Flow Rate**
- 9. Radiator Pressure Drop**
- 11. Radiator Valve Pressure Drop**
- 12. Total Pressure Drop**
- 13. Radiator Rough-In**
- 14. Bracket and Radiator Mounting**
- 15. Tubing and Pipe Adaptors**
- 16. Copper Pipe Adaptor Assembly**
- 17. Isolation and By-Pass Valves**
- 18. Flow Setter and Thermostatic Operator**
- 19. Water Flow**

8/2015 R3

SPECIFICATIONS

	HEIGHT	LENGTH	BASEBOARD EQUIVALENT	BTUH OUTPUT		WEIGHT
				180° F	140° F	
DDR12X16	12	16	3.33	1934	1068	17
DDR12X24	12	24	5.00	2900	1600	24
DDR12X32	12	32	6.67	3866	2133	31
DDR12X40	12	40	8.33	4831	2661	39
DDR12X48	12	48	10.00	5800	3200	46
DDR12X56	12	56	11.67	6766	3733	53
DDR12X64	12	64	13.33	7732	4265	60
DDR16X16	16	16	4.17	2418	1331	23
DDR16X20	16	20	5.21	3022	1665	28
DDR16X24	16	24	6.25	3626	1999	33
DDR16X28	16	28	7.29	4231	2330	38
DDR16X32	16	32	8.34	4835	2665	43
DDR16X36	16	36	9.38	5440	2996	48
DDR16X40	16	40	10.42	6044	3330	52
DDR16X44	16	44	11.46	6648	3665	57
DDR16X48	16	48	12.51	7253	3995	63
DDR20X16	20	16	4.96	2876	1583	28
DDR20X20	20	20	6.19	3593	1979	34
DDR20X24	20	24	7.44	4313	2375	40
DDR20X28	20	28	8.68	5033	2771	46
DDR20X32	20	32	9.91	5749	3166	53
DDR20X36	20	36	11.15	6469	3562	58
DDR20X40	20	40	12.39	7186	3958	64
DDR20X44	20	44	13.63	7906	4354	71
DDR20X48	20	48	14.87	8626	4746	76
DDR24X16	24	16	5.71	3310	1819	31
DDR24X20	24	20	7.13	4135	2276	40
DDR24X24	24	24	8.56	4964	2730	48
DDR24X28	24	28	9.98	5790	3183	56
DDR24X32	24	32	11.41	6619	3641	66
DDR24X36	24	36	12.84	7445	4094	75
DDR24X40	24	40	14.26	8270	4548	81
DDR24X44	24	44	15.69	9100	5002	89
DDR24X48	24	48	17.11	9926	5459	97
DDR24X56	24	56	19.97	11580	6367	114
DDR24X64	24	64	22.82	13235	7278	130
DDR24X72	24	72	25.67	14890	8190	149
DDR36X16	36	16	7.83	4541	2457	48
DDR36X20	36	20	9.79	5678	3071	56
DDR36X24	36	24	11.75	6814	3685	72
DDR36X32	36	32	15.66	9083	4913	88

The above BTUH OUTPUT rating is based on average water temperature and 24° Delta T

WATER CONTENT	
HEIGHT	(GALS./Linear Ft.)
12"	.35
16"	.41
20"	.47
24"	.54
36"	.73

If the heating system contains antifreeze, the proper pH must be maintained. High acidity will damage the radiator and void the manufacturer's warranty.

FITTINGS AND ACCESSORIES	
ITEM #	DESCRIPTION
DDEVK12	12" Wall Bracket Set
DDEVK16	16" Wall Bracket Set
DDEVK20	20" Wall Bracket Set
DDEVK24	24" Wall Bracket Set
DDEVK36	36" Wall Bracket Set
DDA318	Dual Pipe Escutcheon
DD39438*	3/8" Pex Tubing Adapter
DD39412*	1/2" Pex Tubing Adapter
DD39458*	5/8" Pex Tubing Adapter
DDA43112C*	1/2" Copper Pipe Adapter
DDA554	3/4"EK x 1/2" Reducer
DDV71110	Angle Isolation Valve w/By-Pass
DDV72110	Angle Isolation Valve
DDV71510	Straight Isolation Valve w/By-Pass
DDV72510	Straight Isolation Valve
DDA4040	Thermostatic Operator
DD8W	White 8" Radsnap Pipe Cover
DD8C	Chrome 8" Radsnap Pipe Cover

*Tube and pipe adaptors are sold individually.

TAPPING IDENTIFICATION

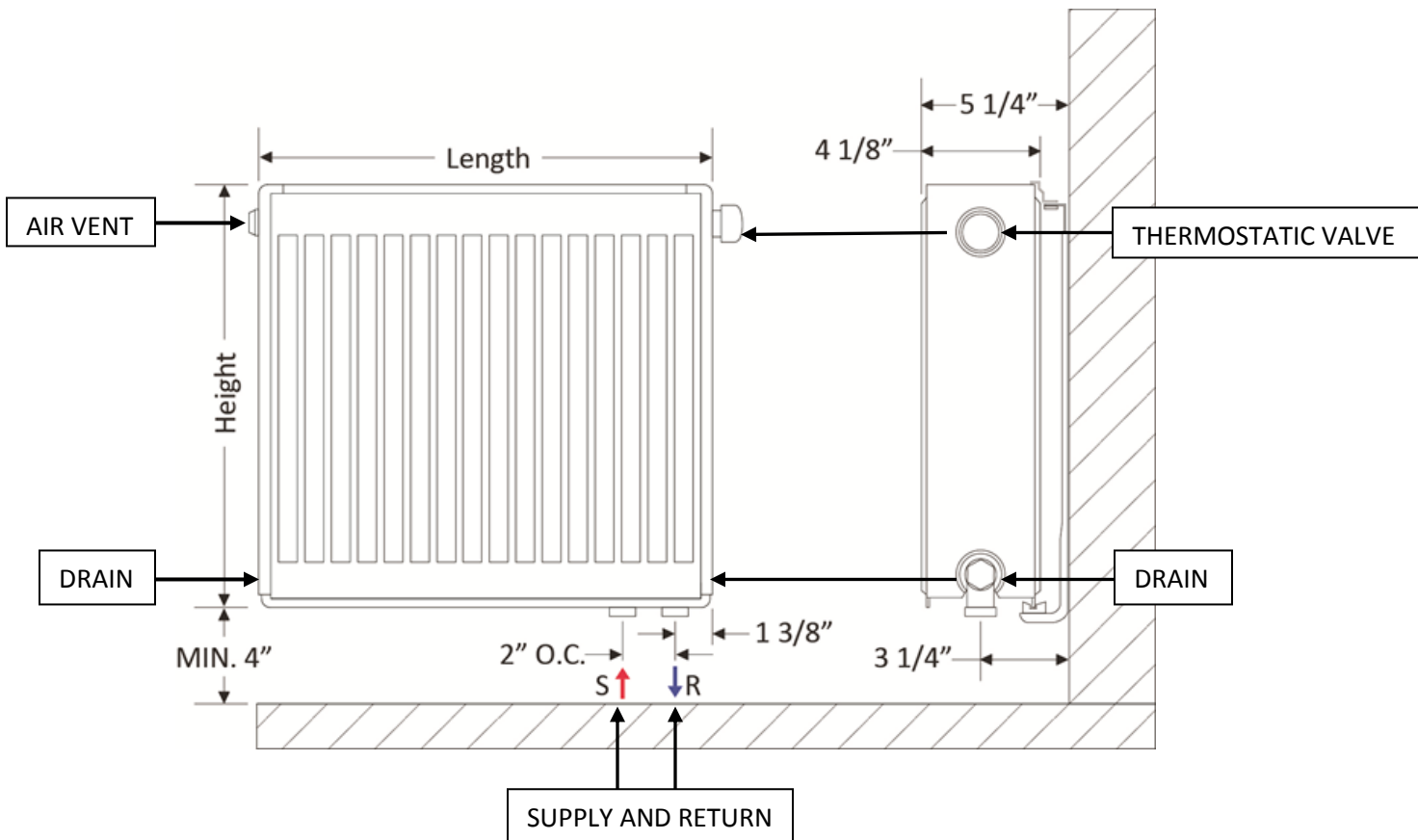

As indicated in the Data Table, Decoro Design steel panel radiators are double panel and available in five different heights; 12", 16", 20", 24" and 36". Each size includes multiple lengths and heat outputs.

Radiators have a light eggshell white epoxy powder coated finish which, if desired, can be repainted by an automobile refinishing professional to a color of your choice.

Each radiator is manufactured with six 1/2" BSP threaded connections, as shown in the illustration above, one of which has a factory installed integral thermostatic valve/adjustable flow-setter, another, a manual air vent, two with drain plugs and a bottom supply and return connection. Many different piping configurations are possible, examples of which will be shown later in this manual.

Each radiator comes standard with two 3/4" male EK x 1/2" male BSP O-Ring adapters, Decoro Design Snap-Grip mounting brackets and a 10 YEAR warranty from the date of installation. Warranty protects the original purchaser from manufacturing defects resulting from faulty materials and/or factory workmanship, and applies to the product only.

INSTALLATION REQUIREMENTS

Decoro Design steel panel radiators are designed to be installed in closed hydronic heating systems, with a maximum operating temperature of 250° F.

If the heating system contains antifreeze, the proper Ph must be maintained. High acidity will damage the radiator and void the manufacturer's warranty.

If radiators are to be installed into an existing heating system, thorough flushing of the boiler and distribution system is required. Continue flushing the system with clean water until it runs clear and debris free for several minutes. For severely dirty systems, a quality cleanser may be necessary. Follow the manufacturer's instructions when using these products.

DIMENSIONS

Height: 12", 16", 20", 24", 36"

Length: 16" to 72" (see specification sheet for available sizes)

Width: 4"

Width including mounting bracket: 5 1/4"

Bottom supply and return: 2" on center

Minimum clearance to floor: 4"

REDUCED AVERAGE WATER TEMPERATURE BTUH OUTPUTS

Radiator Specifications Chart								
MODEL	180°F	170°F	160°F	150°F	140°F	130°F	120°F	110°F
DDR12X16	1934	1696	1477	1269	1068	874	727	519
DDR12X24	2900	2542	2218	1900	1600	1310	1037	781
DDR12X32	3866	3392	2958	2535	2133	1747	1382	1041
DDR12X40	4831	4237	3695	3170	2661	2184	1726	1300
DDR12X48	5800	5087	4436	3804	3200	2620	2074	1559
DDR12X56	6766	5933	5175	4439	3733	3057	2419	1819
DDR12X64	7732	6783	5913	5074	4265	3494	2763	2081
DDR16X16	2418	2119	1849	1583	1331	1092	863	648
DDR16X20	3022	2651	2310	1982	1665	1365	1078	812
DDR16X24	3626	3180	2771	2378	1999	1638	1293	972
DDR16X28	4231	3709	3235	2774	2330	1911	1512	1136
DDR16X32	4835	4241	3695	3170	2665	2184	1726	1297
DDR16X36	5440	4770	4159	3566	2996	2457	1941	1460
DDR16X40	6044	5302	4620	3961	3330	2726	2156	1621
DDR16X44	6648	5831	5083	4357	3665	2999	2371	1784
DDR16X48	7253	6360	5545	4753	3995	3272	2590	1945
DDR20X16	2876	2521	2197	1883	1583	1300	1024	771
DDR20X20	3593	3153	2747	2354	1979	1621	1279	962
DDR20X24	4313	3780	3295	2825	2375	1945	1535	1153
DDR20X28	5033	4412	3845	3296	2771	2269	1791	1347
DDR20X32	5749	5043	4392	3767	3166	2593	2047	1539
DDR20X36	6469	5670	4942	4238	3562	2914	2303	1733
DDR20X40	7186	6302	5490	4709	3958	3238	2559	1924
DDR20X44	7906	6933	6040	5179	4354	3562	2815	2115
DDR20X48	8626	7561	6590	5650	4746	3886	3071	2310
DDR24X16	3310	2900	2528	2167	1819	1488	1177	884
DDR24X20	4135	3627	3160	2706	2276	1863	1471	1105
DDR24X24	4964	4350	3793	3248	2730	2235	1764	1327
DDR24X28	5790	5077	4424	3791	3183	2607	2057	1546
DDR24X32	6619	5800	5057	4336	3641	2979	2354	1767
DDR24X36	7445	6527	5688	4872	4094	3351	2648	1989
DDR24X40	8270	7250	6318	5415	4548	3722	2941	2211
DDR24X44	9100	7977	6952	5957	5002	4094	3235	2429
DDR24X48	9926	8704	7583	6496	5459	4466	3528	2651
DDR24X56	11580	10154	8847	7581	6367	5213	4118	3095
DDR24X64	13235	11604	10111	8663	7278	5957	4705	3535
DDR24X72	14890	13054	11376	9745	8190	6701	5295	3978
DDR36X16	4541	3968	3443	2938	2457	1999	1569	1170
DDR36X20	5678	4957	4306	3675	3071	2501	1962	1464
DDR36X24	6814	5951	5166	4408	3685	2999	2354	1757
DDR36X32	9083	7933	6885	5879	4913	4002	3142	2341

The above BTUH OUTPUT rating is based on average water temperature and a 24° F Delta T

SIZING

If unfamiliar with heating system design using steel panel radiators, please consult a qualified distributor for guidance before proceeding.

1. An accurate heat loss must be performed to determine the load of the space(s) to be heated.
2. Based on a predetermined design water supply temperature, choose a radiator from the specification chart(s) that most closely matches the heat loss of the space in which it is to be installed. If a single radiator does not have enough capacity, divide the load evenly into two or three radiators. Standard ratings are based on 68°F EAT, the average water temperature and a 24°F water Delta T across the radiator.
3. Radiators preferably should be mounted on an outside wall.
4. Determine if the wall chosen is large enough to accommodate the radiator. If not, multiple radiators may be required.
5. Radiators must be mounted a minimum of 4" above the floor. If straight valves are to be incorporated, additional floor clearance should be considered to ease the installation of the tubing/pipes onto the radiator.

FLOW RATE

Flow rates for a Decoro Design steel panel radiator system are based on the calculated heat loss of each heating zone. Using the calculated heat loss, determine the Btu load of each individual zone. The following formula will be used to calculate the flow rate from the Btu load of the individual zones. The following information is provided as informational only; system design should be conducted by a qualified individual with panel radiator experience.

$$\text{Flow Rate (GPM)} = \text{Heat Loss (Btu/h)} / 500 \times \text{Delta T (F)}^*$$

Delta T is the temperature difference between the supply and return of the radiators in each zone. Standard output ratings are based on a 24 degree Delta T (Temperature Drop) between the supply and return of each panel radiator.

The following table provides several divisors for the above formula to make calculations quicker and easier.

Delta T (F)	Divisor
10	5,000
15	7,500
20	10,000
24*	12,000
25	12,500
30	15,000
35	17,500

* Standard Rating Application

FLOW RATE (Contd.)

$$\text{Flow Rate (GPM)} = \text{Heat Loss (Btu/h)} / \text{Divisor (above chart)}$$

Example:

Calculated Heat Loss of 23,500 Btu/h

24 Degree Delta T

$$\text{Flow Rate (GPM)} = 23,500 / 24 = 12,000 \text{ (above chart)}$$

$$\text{GPM} = 23,500 / 12,000$$

$$\text{GPM} = 1.96$$

Series Piping of panel radiators is **not** a preferred method of installation due to the potential of extreme temperature drops across the entire piping circuit. Very careful consideration of system design is required before proceeding. Please consult a qualified distributor

RADIATOR PRESSURE DROP

The following chart will be used to determine the pressure drop for each Decoro Design Double Panel Radiator.

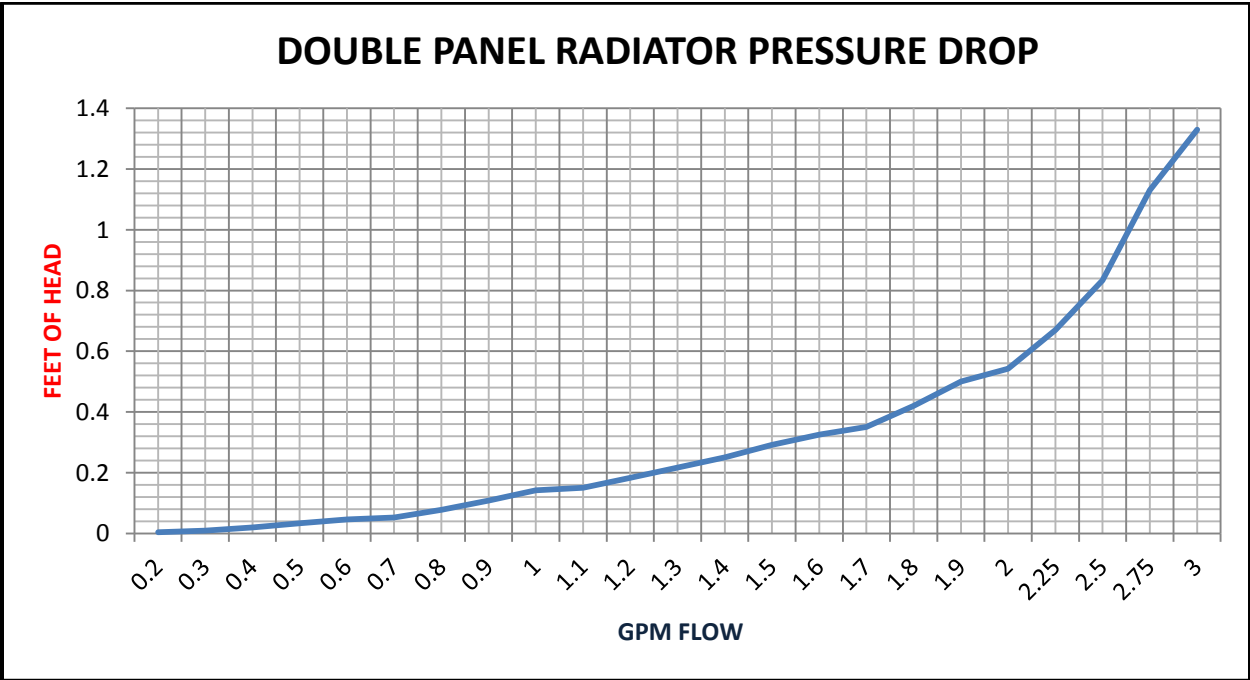

To determine the pressure drop for a radiator, first determine the gpm flow through that radiator using the flow rate formula on the previous page. Once the flow rate is determined, locate the corresponding number on the bottom axis of the chart, move straight up until you intersect the pressure drop curve, now draw a line to the left axis and read the pressure drop in feet of head. Pressure drop through radiator is based on the flow setter valve being in the full open position (position #6, see Thermostatic Valve Assembly chapter).

Repeat this procedure for each individual radiator. If the radiators are to be installed in a series circuit, add the pressure drops of each radiator together to determine the total radiator pressure drop. If the radiators are piped in a parallel circuit use the highest single radiator pressure drop as the total radiator pressure drop for that circuit.

In a series circuit the total loop flow rate passes through each radiator, in a parallel circuit the flow rate is divided among the radiators.

Example:

Determine the pressure drop of a Decoro Design DDR24X64 radiator, at standard conditions 13,235 Btu, with a 24 degree temperature drop.

$$\text{Gpm} = 13,235 / 12,000$$

$$\text{Gpm} = 1.10$$

Locate 1.10 gpm on the bottom axis of the above chart, move up to the pressure drop curve, follow the intersecting line to the left axis and read the pressure drop in feet of head, approximately .15. If this radiator was to be installed in a series circuit with 3 other radiators of the same size then the pressure drop through all the radiators would be $.15 \times 3$ (radiators) = .45 foot of head.

The use of heating system antifreeze may affect the flow rate and pressure drop characteristics of a heating system. Please consult a qualified distributor for guidance.

“H” VALVE RADIATOR VALVE PRESSURE DROP

The following chart will be used to determine the pressure drop through all four types of Decoro Design radiator valves.

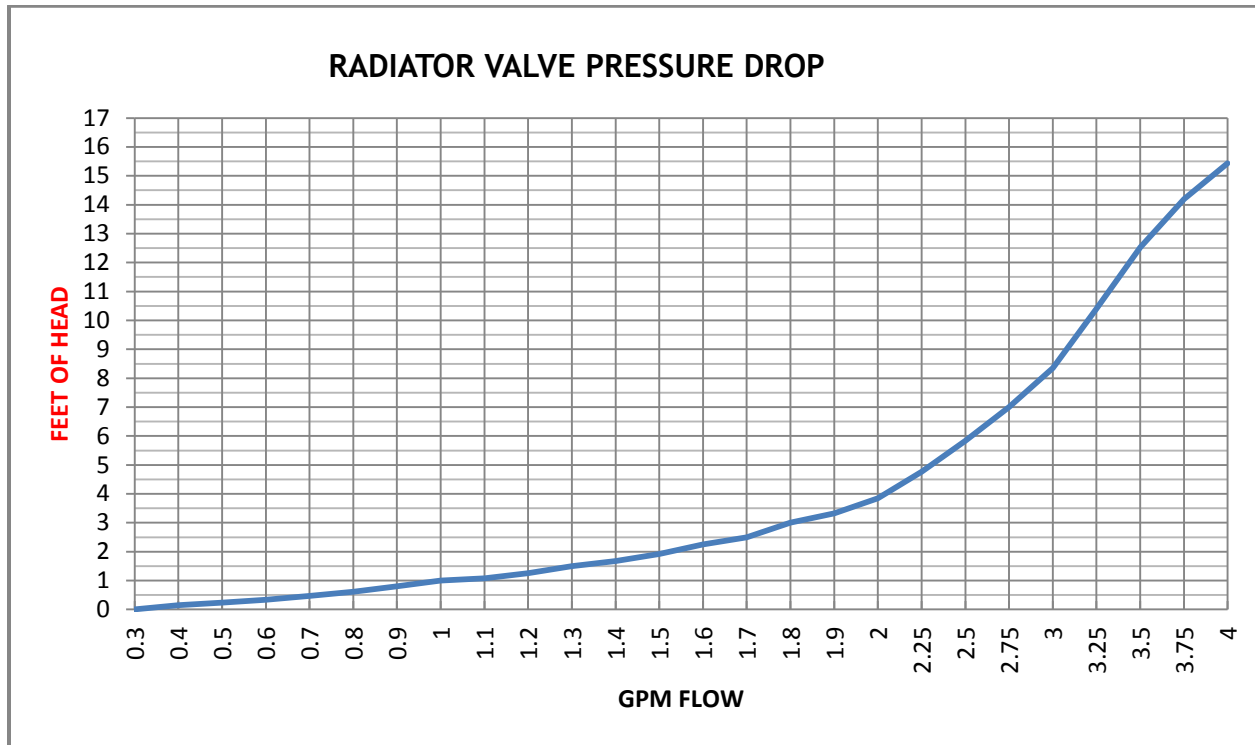

Determining the pressure drop for the radiator valve is the same procedure used for the radiators on the previous page. Find the calculated flow rate in Gpm on the bottom axis of the chart, move straight up until you intersect the curve then draw a line to the left axis and read the pressure drop in feet of head.

Repeat this procedure for each individual radiator. If the radiators are to be installed in a series circuit, add the pressure drop of each valve in the circuit together to determine the total valve pressure drop. If the radiators are to be piped in parallel the valve with the highest pressure drop will determine the total valve pressure drop for that circuit.

In a series circuit the total loop flow rate passes through all the valves, in a parallel circuit the flow rate is divided among the valves.

Example:

Using the example from the previous page; a DDR24X64 radiator emitting 13,235 Btu @ 1.1 Gpm flow

Find 1.1 Gpm on the bottom axis of the chart, move straight up until you intersect the curve, now follow the horizontal line to the left axis and read the pressure drop for this valve in feet of head, approximately 1.0’.

If there were 3 of these radiators installed in a series circuit the total valve pressure drop would be 3 feet of head ($3 \times 1.0' = 3'$). In a parallel circuit, with the same 3 radiators, the total valve pressure drop for the circuit would be 1.0’, the largest individual valve pressure drop in the parallel circuit.

TOTAL PRESSURE DROP

Total Piping Circuit Pressure Drop

The total circuit pressure drop is calculated by adding together the total radiator pressure drop, total H-valve pressure drop, boiler pressure drop, and the supply and return piping pressure drop (including all devices installed within the piping. (Flowcheck, airscoop, valves etc.).

Circulator Sizing

Circulator size is determined by two criteria; flow rate in gpm and pressure drop in foot of head. After these two items have been calculated for a particular piping circuit, a circulator can be chosen using the manufacturer's performance curve.

Example;

One Decoro Design DDR24X72 panel radiators, 14,890 Btus, installed in a piping circuit designed for a 24 degree temperature drop across the radiator.

Flow rate = $1 \times 14,890 / 12,000$

Flow rate = 1.24 gpm

Radiator Pressure drop = .19 foot of head (from radiator pressure drop chart)

H-valve pressure drop = 1.5 foot of head (from H valve pressure drop chart)

Boiler pressure drop = 1 foot of head (from manufacturers' information)

Supply & return pressure drop = 4.5 foot of head (calculated)

Total Circuit Pressure Drop = 7.19 foot of head

1.24 gpm @ 7.19 foot of head

Using the manufacturer's performance curves, choose a circulator that meets or slightly exceeds the circuits' requirements, see example below.

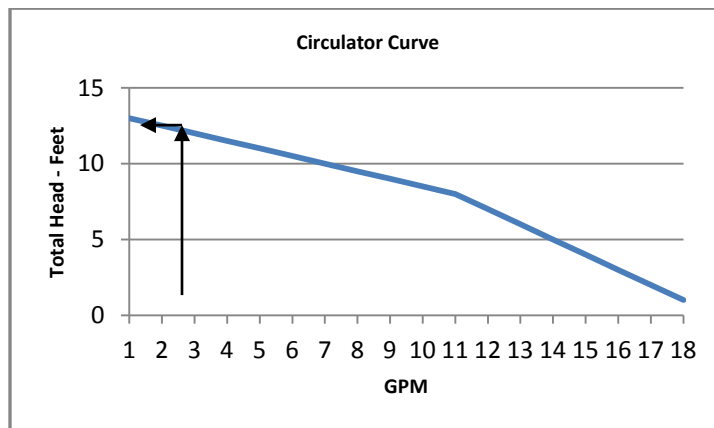

RADIATOR ROUGH-IN

Dimensions

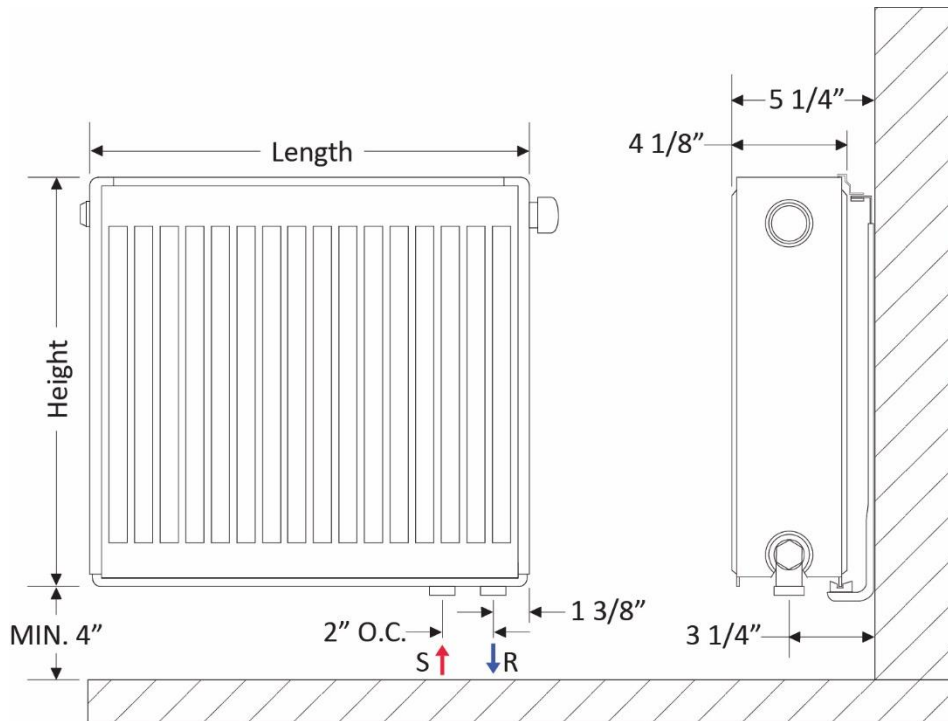

Radiators should be placed on an outside wall, below a window if possible. Check the installation location and determine if adequate space is available to accommodate the panel size chosen.

Decoro Design recommends the use of the bottom supply and return connections. These connections are located near the end of the radiator. The return connection is 1 3/8" from the end and the supply is 2" further in towards the radiator center. This connection location will accept any one of the four optional H-Valves.

Decoro Design panel radiators are reversible, dependent upon which side is facing the rooms' interior the supply and return connections may be located either on the left or right hand side. Be sure the proper connection location is selected before drilling piping holes.

See the above figure for additional dimensions and rough-in information.

The optional side connections may be used in lieu of the preferred bottom connections. Care must be taken when using these connections. In some cases the integral thermostatic/flow-setter valve will be by-passed causing continued, uncontrolled heating of the radiator. The plugs removed from the side connections must be installed in the unused bottom connections before filling the system with water. Decoro Design valves are not compatible with the side connections.

See the 'Piping Options' section of this manual for more information.

BRACKET AND RADIATOR MOUNTING

Decoro Design Snap-Grip mounting brackets must be securely fastened to the wall. Frame type construction requires the brackets to be fastened to the wall studs, preferably towards the ends of the radiator. With 16" long radiator, if at least bracket cannot be secured to a wall stud, use 3/8" (minimum) hollow wall toggle bolt fasteners. Additional bracket sets are available if required.

Each pair of brackets includes; 2 mounting bolts and plastic masonry anchors; do not use these anchors on frame type construction (figure 1).

Install the brackets, aligning the bottom with the desired height of the radiator bottom; a minimum of 4" is required (additional space should be considered when incorporating straight valves to ease pipe/tubing installation). Plumb the brackets against the wall and mark the screw locations. Drill pilot holes, install the screws (don't tighten to the wall), hang the brackets from the screws and tighten completely.

Extend the top clamp by pulling the nylon thumb retainer towards you approximately 1/4" of an inch while lifting up on the top clamp, repeat for all brackets. Lift the radiator and angle the bottom towards the wall, set the inside water panel into the nylon bottom bracket (figure 2). Tilt the top of the radiator towards the wall, when parallel with the wall; push the top clamp down onto the top rear of the radiator until a click is heard (figure 3). An adjustment screw is installed on the top of the top clamp; this permits minor adjustments to the clamp location if necessary (figure 3).



Figure 1

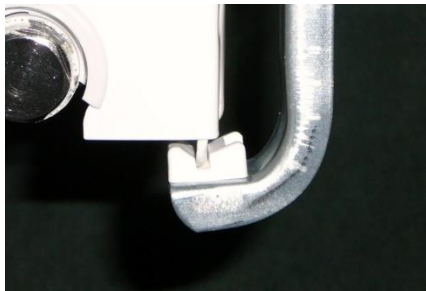

Figure 2



Figure 3



Figure 4

TUBING AND PIPE ADAPTORS

Decoro Design panel radiators may be connected directly to the system piping using the available pex tubing or copper pipe adapters. Isolation and by-pass valves are also available and are installed between the radiator and tubing/pipe adapters.

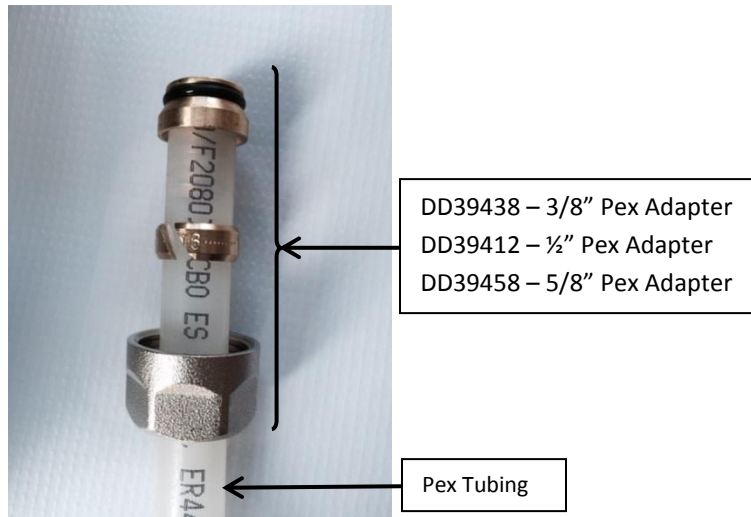

Pex Tubing Adapter Assembly

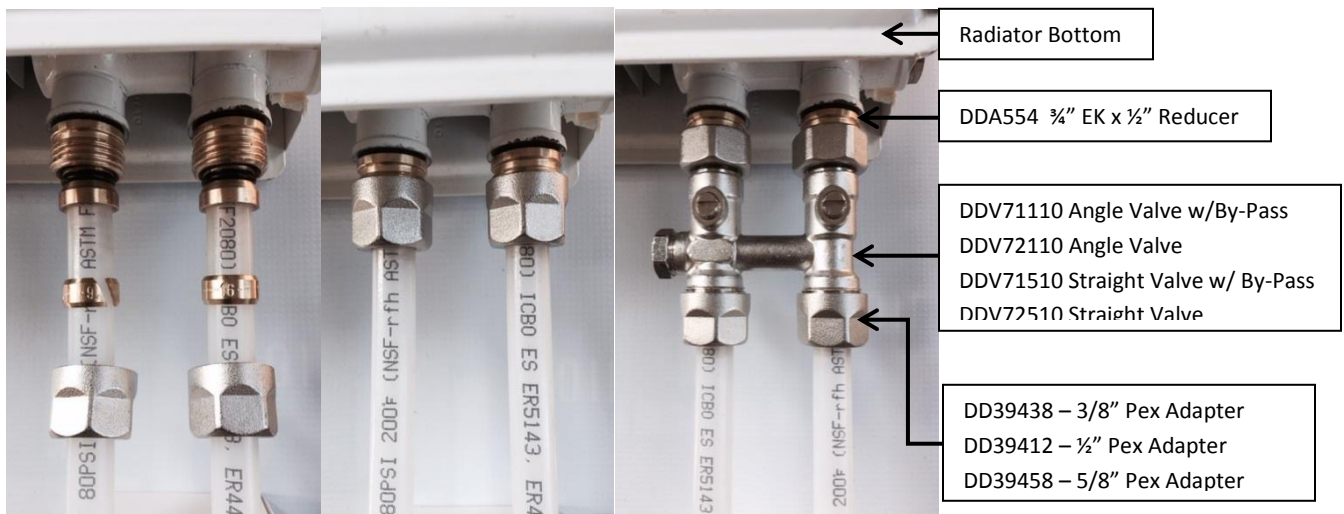

Pipe thread sealant is not required. Insert the DDA554 reducers into the supply and return connections of the radiator and tighten with a 12mm Allen wrench. Choose the proper size pex tubing adapter. Slide the nut onto the tubing followed by the compression ring, and then insert the o-ring fitting into the end of the tubing. Firmly insert the tubing into the DDA554 reducer until it bottoms out and hold it there. Slide the nut and compression ring onto the DDA554 reducer and tighten. Do not overtighten.

COPPER PIPE ADAPTER ASSEMBLY

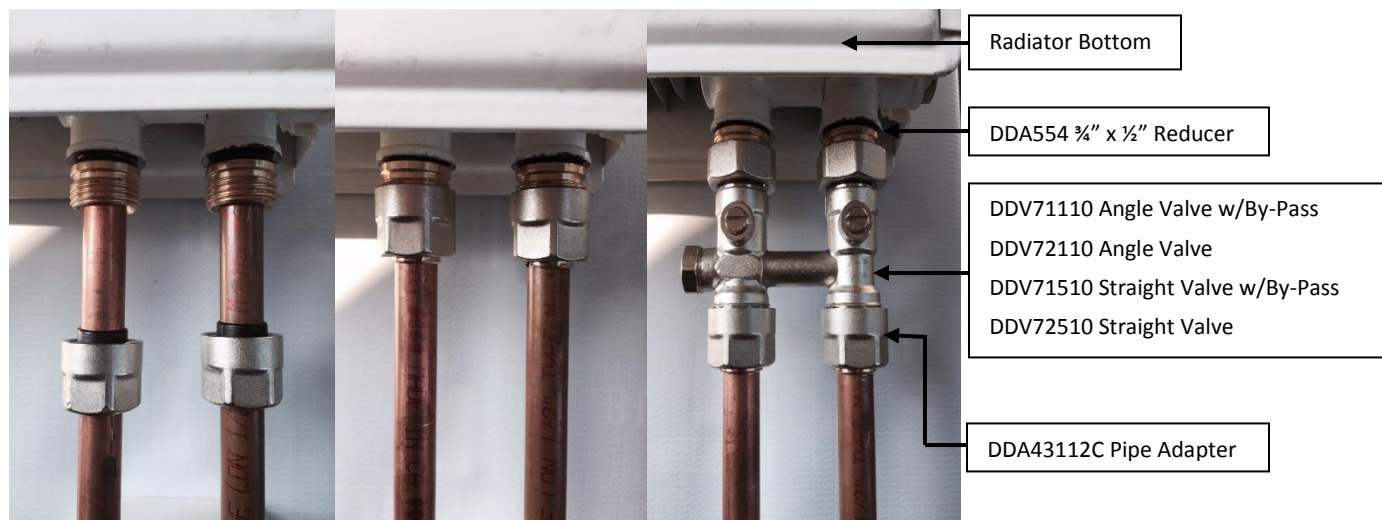

Pipe thread sealant is not required. Insert the DDA554 reducers into the supply and return connections of the radiator and tighten with a 12mm allen wrench. Slide the DDA43112C-1/2" copper adapter (one piece) onto the copper pipe. Insert the copper pipe into the reducer and hold it. Slide the copper adapter up the pipe and attach it to the DDA554 reducer and tighten. Do not overtighten.

Installation assembly using valves is the same as described above. The only difference is the addition of one of the valves between the DDA554 reducer and tubing or pipe adapter.

ISOLATION AND BY-PASS VALVES

By-pass Valves

Isolation Valves



Isolation valves DDV72110 & DDV72510, with their integral ball valves and O-ring seats, are designed to make radiator maintenance and removal quick and easy.

By-Pass valves DDV71110 & DDV71510, are available for use in one pipe systems. They provide the same isolation feature along with an adjustable by-pass capability. Preset to 35% flow through the radiator and 65% through the by-pass. Because of high pressure drop through the valve, a maximum circuit flow rate must not exceed 2 GPM when using either the straight or angled By-Pass Valves. A maximum of 4 radiators may be connected to a By-Pass Valve piping circuit.

The by-pass feature is adjustable. Remove the cap and insert a 5mm allen wrench to adjust. Turning the by-pass screw clockwise closes the by-pass and forces more water flow through the radiator. To reset the adjustment screw to the factory setting, turn clockwise until the by-pass is completely closed then turn counter-clockwise approximately 1 $\frac{3}{4}$ turns.

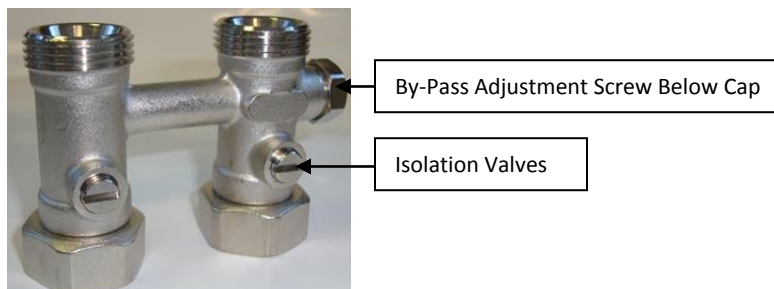

INTEGRAL THERMOSTATIC VALVE AND FLOW SETTER ASSEMBLY

Decoro Design panel radiators have integral thermostatic and flow setter valves installed as standard equipment, thermostatic operators are optional.

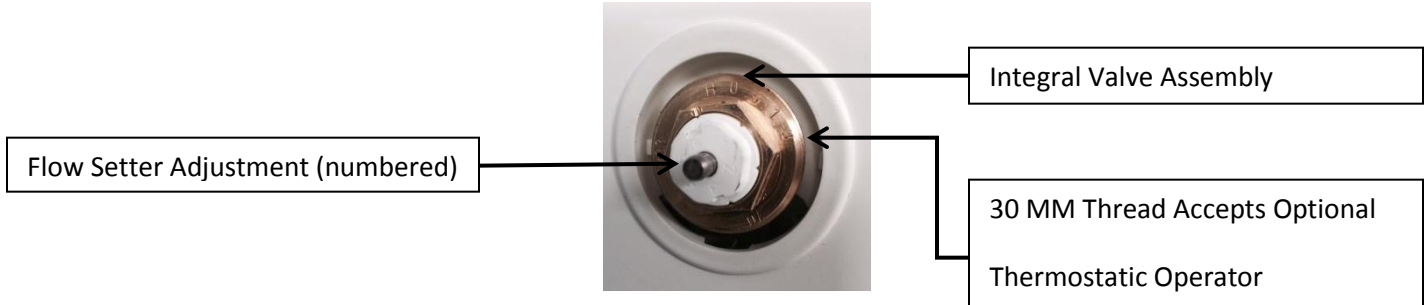

Flow Setter	
Number	Percentage Open
1	10
2	20
3	30
4	40
5	50
6	100

Flow Setter is factory set to “6”.

Flow Setter is adjusted by removing the white factory installed white cap (turn counterclockwise) and then turning the inner gland (picture above) to the corresponding number. When finished, replace the white cap but do not tighten. If the cap is tightened water flow through the valve will be further impeded.

As the flow setter valve opening is reduced the pressure drop (resistance) through the radiator will increase. Considering the additional pressure, circulator performance may need to be re-assessed.

Optional Thermostatic Operator Settings

Install the optional thermostatic operator by first removing the factory installed white cap covering the thermostatic valve (turn counterclockwise). Thermostatic valve should be set to “6”. Set the thermostatic operator to # 5 and then screw onto the valve and tighten. Adjust the operator to the desired room temperature using the reference table below.

Thermostatic Operator	
Number	Approximate Room Temperature
Snowflake	43.7 F
1	51.8 F
2	60.8 F
3	68.0 F
4	75.2 F
5	81.5 F



WATER FLOW

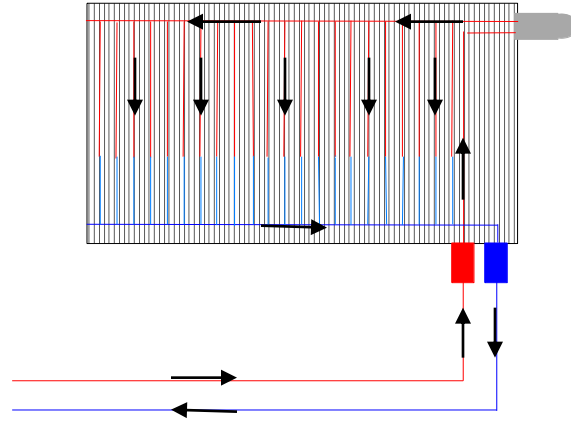

Piping schematics provided on the following pages are informational only and just a small sampling of possible piping arrangements. Sound engineering practices must be adhered to when designing any steel panel radiator heating system.

Series Circuit (Maximum Circuit Flow Rate Is 1.5 GPM, and/or 3 Radiators). This is not a preferred method of installation because of the potential of very large temperature drops across the piping circuit. Please consult a qualified individual before proceeding.

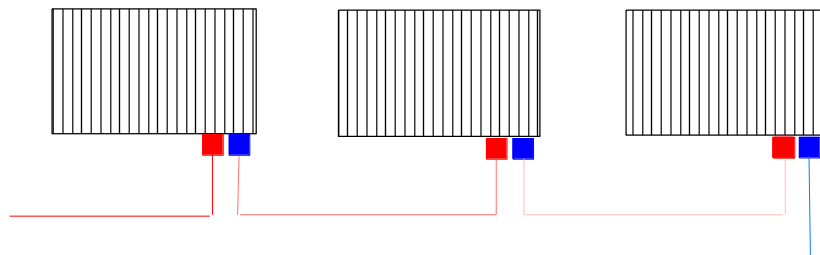

Series Circuit w/By-Pass Valves (Maximum Circuit Flow Rate Is 2 GPM, and/or 4 Radiators).
This is not a preferred method of installation because of the potential of very large temperature and pressure drops across the piping circuit. Please consult a qualified individual before proceeding.

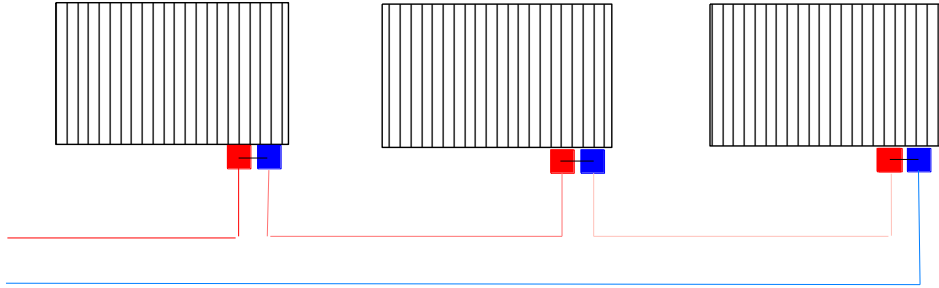

Monoflo (Diverter Tee)

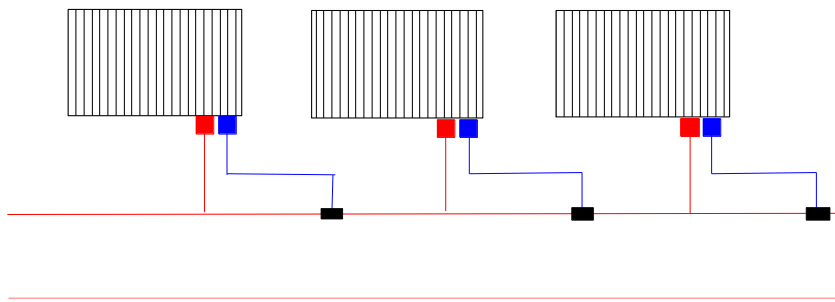

Monoflo w/Thermostatic Operators

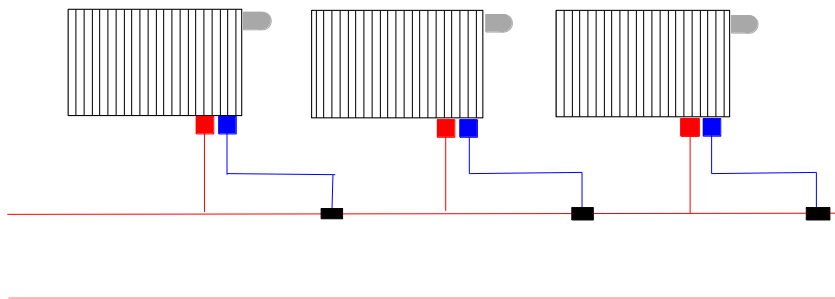

Downflow Monoflo w/ Thermostatic Operators*

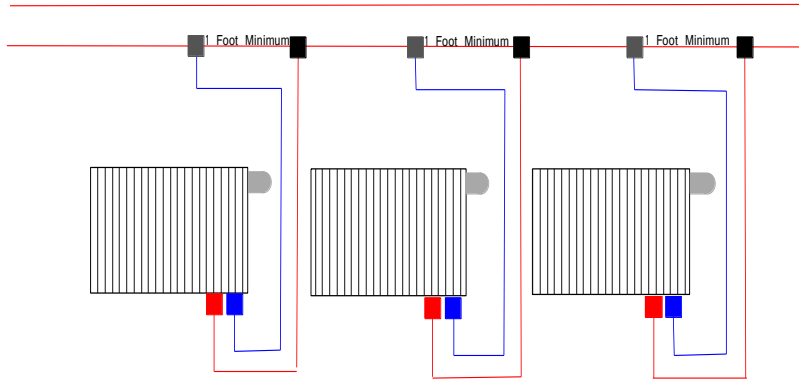

*Two monoflow tees required on each radiator

Direct Return

(Flow Balancing Required)

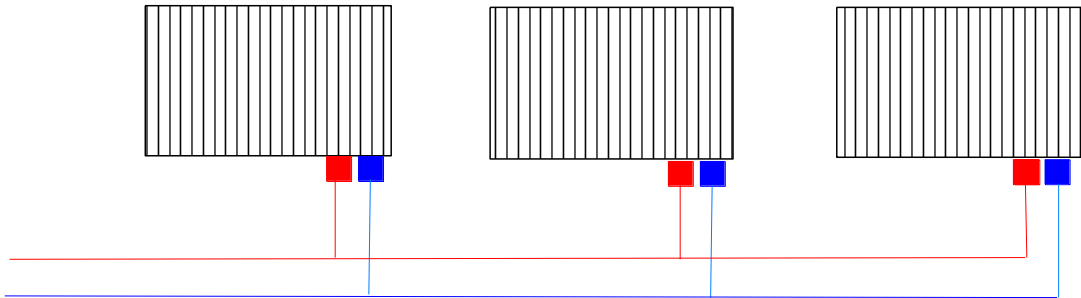

Direct Return w/Thermostatic Operators

(Flow Balancing Required)

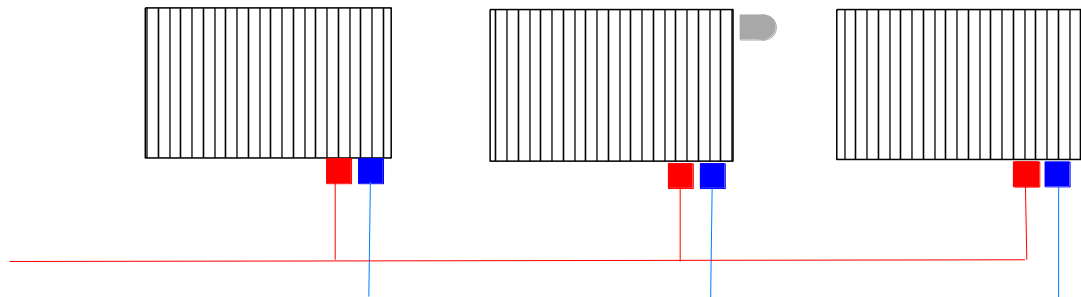

Reverse Return With or Without Thermostatic Operators

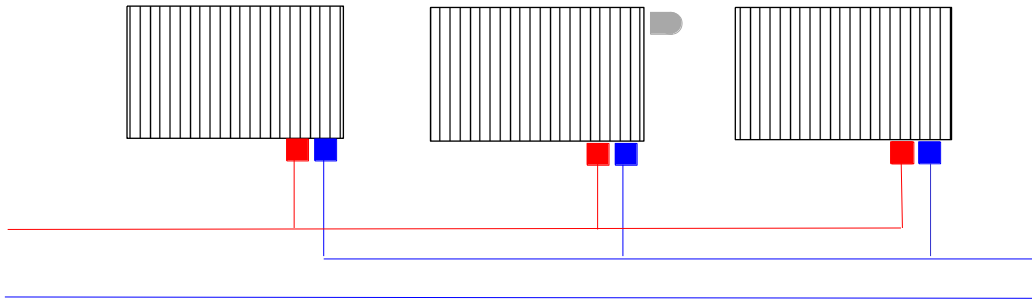

Homerun

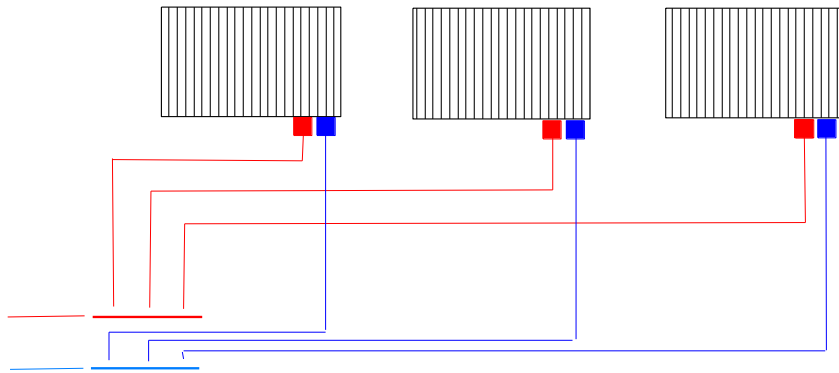

Homerun with Thermostatic Operators and By-Pass Valve

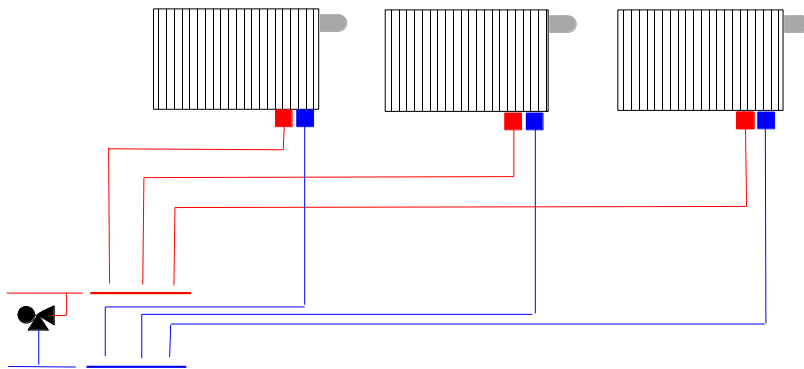

Homerun with Electric Zone Valve and By-Pass Valve

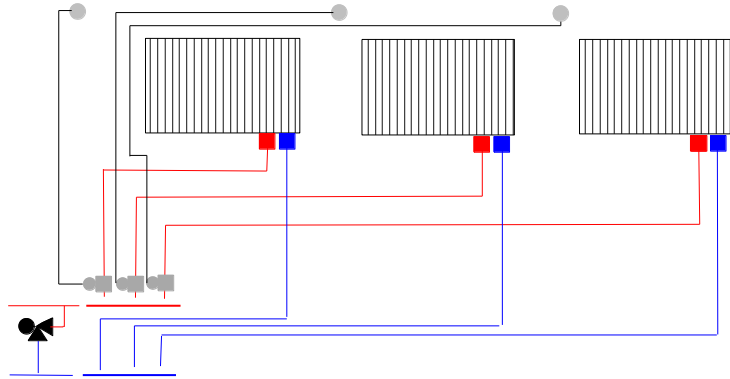

Homerun with Thermostatic Operators and Variable Speed Delta T Circulator

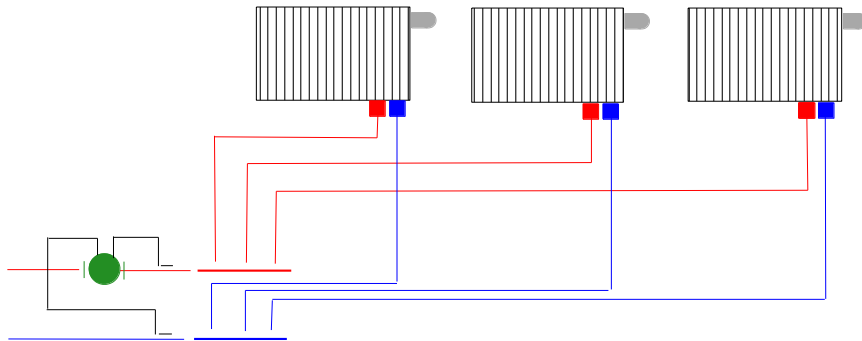

PIPING OPTIONS

Decoro Design recommends their panel radiators be connected to the piping system through the bottom supply and return connections. This guarantees complete water flow through the radiator and proper operation of the flow-setter and thermostatic valve.

Should it be impossible or impractical to use bottom connections, other piping configurations are possible using the side connections. Extreme care must be used to assure proper water flow and flow-setter and thermostatic valve operation. Improper installation will result in poor system performance, reduced or no radiator Btu output, or lack of temperature control.

Decoro Design isolation and diverter valves, both straight and angle, fit the supply and return connections on the bottom of the radiator only. Additional fittings may be required and they may not be available from this manufacturer.

Alternate Piping Arrangement Examples

System designer and/or installer are responsible to determine whether proper radiator and/or system operation will result using alternate piping arrangements. Examples are provided for illustrative purposes only!

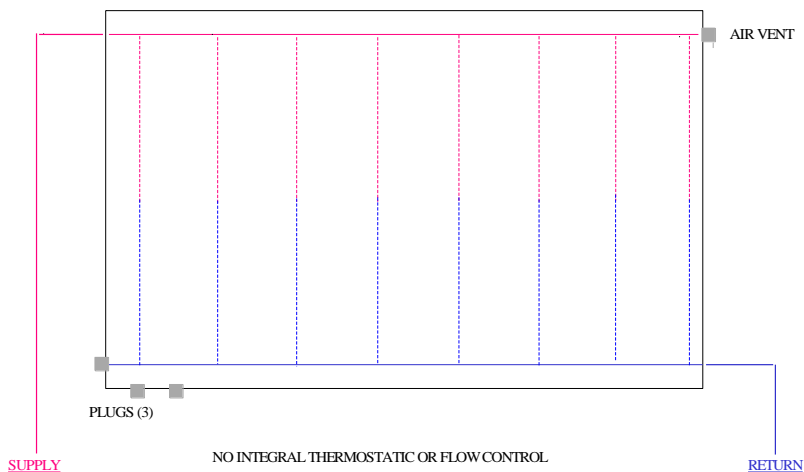

[PANEL RADIATORS - ALTERNATE PIPING ARRANGMENT 1]

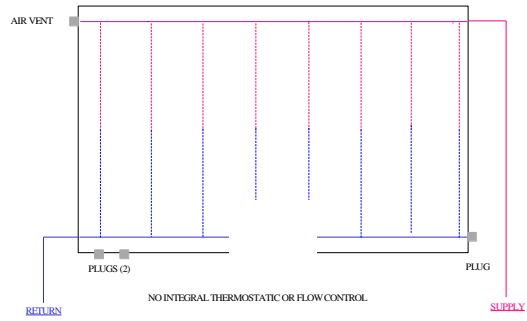

PANEL RADIATORS - ALTERNATE PIPING ARRANGEMENT 2

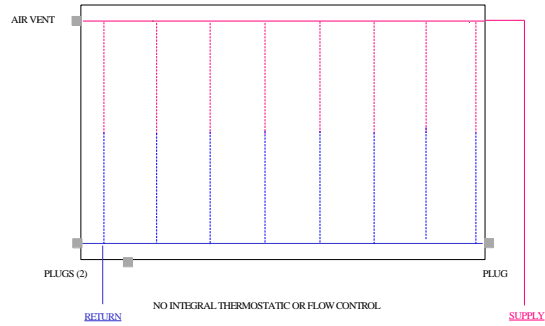

PANEL RADIATORS - ALTERNATE PIPING ARRANGEMENT 3

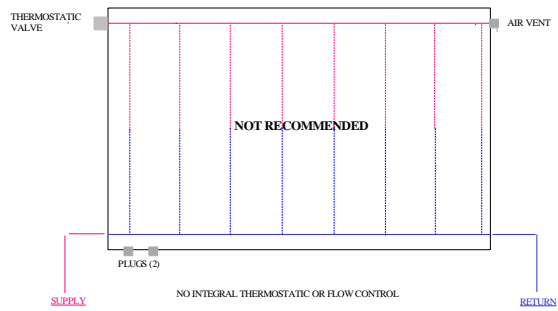

PANEL RADIATORS - ALTERNATE PIPING ARRANGEMENT 4

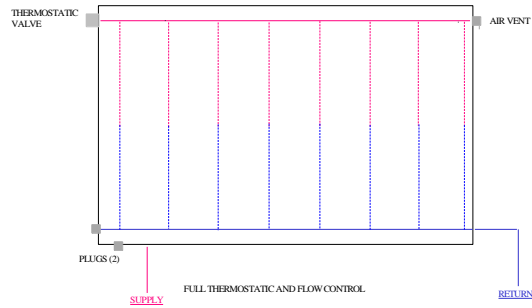

PANEL RADIATORS - ALTERNATE PIPING ARRANGEMENT 4

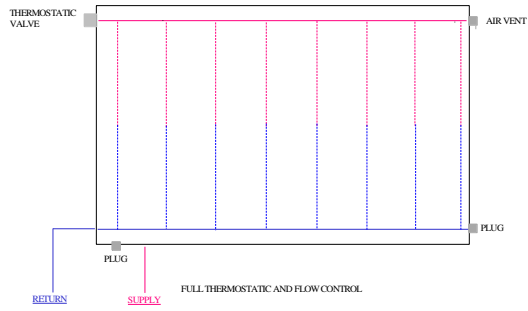

PANEL RADIATORS - ALTERNATE PIPING ARRANGEMENT 5

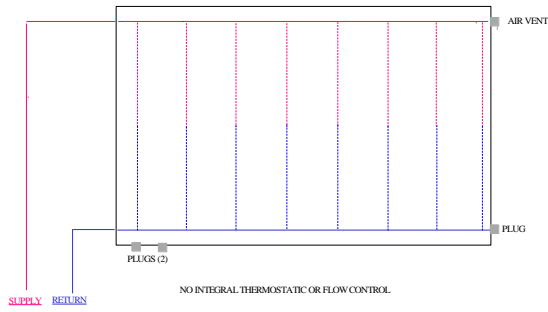

PANEL RADIATORS - ALTERNATE PIPING ARRANGEMENT 6

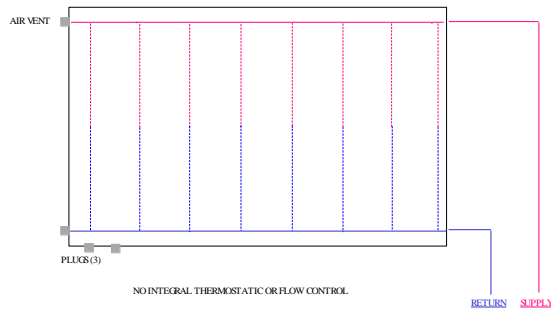

PANEL RADIATORS - ALTERNATE PIPING ARRANGEMENT 7

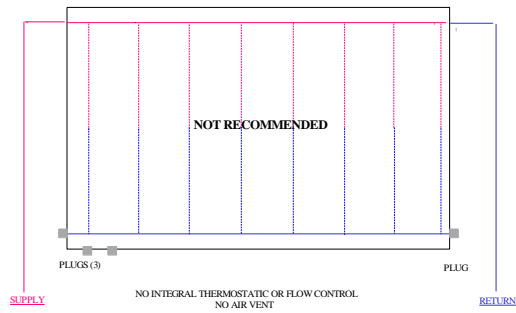

PANEL RADIATORS - ALTERNATE PIPING ARRANGEMENT 4

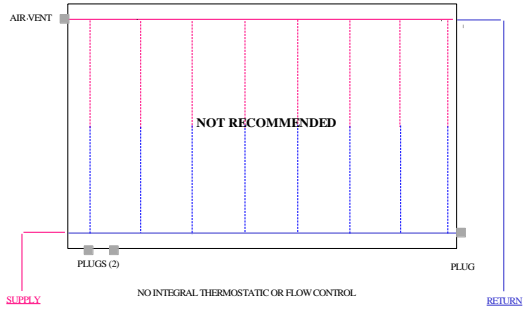

PANEL RADIATORS - ALTERNATE PIPING ARRANGEMENT 4

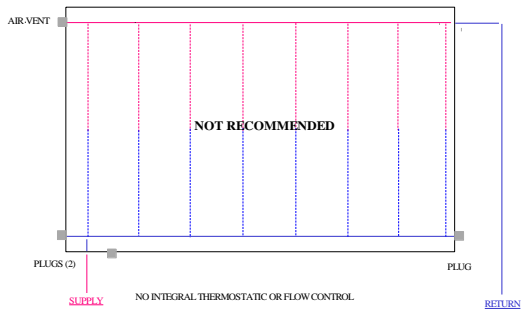

PANEL RADIATORS - ALTERNATE PIPING ARRANGEMENT 4

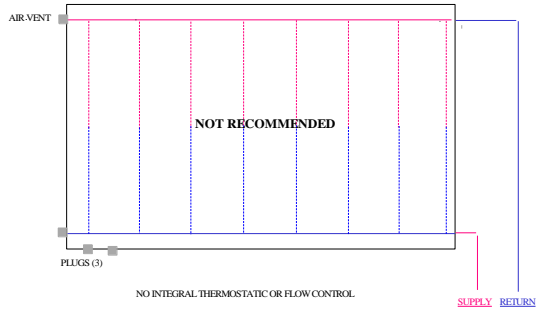

PANEL RADIATORS - ALTERNATE PIPING ARRANGEMENT 4

FOLLOWING PAGES INTENTIONALLY LEFT BLANK

